

MODEL  
**HDI-250F**

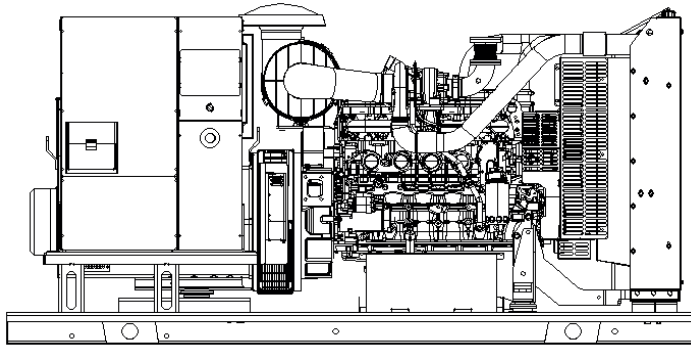

60Hz STANDBY POWER RATINGS

250kW/60Hz//1800RPM



VOLTAGE VAC	120/240V	120/208V	139/240V	277/480V	347/600V
RATING	Standby	Standby	Standby	Standby	Standby
PHASE	N/A	3	3	3	3
PF	N/A	0.8	0.8	0.8	0.8
HZ	N/A	60	60	60	60
KW	N/A	250	250	250	250
KVA	N/A	312.5	312.5	312.5	312.5
AMPS	N/A	867	752	376	301

**Description**

HIPOWER<sup>®</sup> Heavy Duty Industrial generators are an efficient, reliable and versatile source of back-up electrical power that have been designed to operate in the most extreme working conditions. All HIPOWER<sup>®</sup> Heavy Duty Industrial generators combine an innovative design and the use of high quality materials that provide the user with the most dependable power that can be relied on for non-stop power with easy to operate controls.

Powered by a radiator-cooled, industrial FPT Diesel engine that meets current Environmental Protection Agency (EPA) TIER 3 exhaust emission regulations, driving a single bearing, four-pole, three-phase alternator, with IP23 protection. The Emergency Power kVA rating is given with a 125 degree °C alternator winding temperature rise.

**HIPOWER<sup>®</sup> Features and Benefits**

**FPT Diesel Engine:** Long-life, heavy-duty, 4-cycle, direct injection engine for economy of operation and maximum reliability and durability.

**Cooling:** Radiator with belt driven pusher fan.

**Air Filter:** Heavy-duty replaceable element air-cleaner.

**Alternator:** Single bearing, rotating field, self-excited, self-ventilated, 12-wire re-connectable, 60Hz brushless alternator and Class H insulation. Automatic voltage regulator (AVR) providing close voltage regulation and skVA starting capability for electric motor loads.

**Enclosure:** Fully sound attenuated enclosure, manufactured using 7-gauge steel and thicker for the base; 12-gauge and 14-gauge for the enclosure, Interpon A4700 primer, in combination with Interpon 600 series coatings, are designed for exterior exposure and offers excellent light and weather resistance exceeding 1400-hr salt spray test. A 1" thick layer of durable sound insulating, oil and fire resistant foam material is installed all around the inside of the enclosure to allow high-pressure water cleaning. Vertical air discharge for quiet operation. Wide steel lockable access doors with rubber seals, easy access for maintenance and service activities, lift off Die Cast Zinc hinges textured black powder coat and corrosion resistant hardware and fasteners.

**Exhaust:** Low noise, steel residential-type exhaust silencer with rain cap.

**Fuel Filtration:** Standard and secondary water separator with visible level on fuel filters.

**Controls:** Digital control panel with manual and automatic start and stop features. Many programmable automatic functions for local and remote controls with LED lights and tamper proof engine hour recorder.

**Certification:** Generator set is UL 2200 Listed and CSA certified and meets ISO 8528-5.

## APPLICATION DATA

ENGINE SPECIFICATION		LUBRICATION SYSTEM	
Manufacturer	FPT - Iveco	Oil pan capacity - gal (L)	6 (23)
Model	C87TE1D	Oil pan capacity with filter - gal (L)	7.4 (28)
EPA certified	Tier 3	Oil cooler	Liquid
Crankshaft speed	1,800 rpm	Recommended lubricating oil grade	SAE 10W-30 / ACEA E3/E5 (refer to owners manual)
Type	Diesel, 4-stroke	Oil consumption at full load	< 0.1% of fuel consumption
Injection	Direct	Oil pressure – psi (kPA)	72.6 (500)
Aspiration	Turbocharged aftercooled air/air	<b>ENGINE ELECTRICAL SYSTEM</b>	
Number of Cylinders	6	Starting motor voltage	24 volt
Cylinder arrangement	In-line	Cold Cranking Amps - minimum	650 Amp
Displacement CID (liters)	530.8 (8.7)	Battery charging Alternator	90 Amp
Bore and Stroke ins (mm)	4.6 x 5.3 (117 x 135)	Battery capacity	650CCA 850CA 115RC GROUP SIZE 24F
Nominal power	375 hp		
Cooling	Liquid		
Governor	Electronic		
Governor Regulation Class	ISO 8528 Part 1 Class G3		
Frequency Regulation	Isochronous		
Starting motor & alternator	24 Volt		
Compression ratio	16.5:1		
Air cleaner type	Heavy duty - single cartridge		
<b>ALTERNATOR SPECIFICATION</b>			
Manufacturer	STAMFORD		
Model 120/240V Single phase	N/A		
Model 120/208V Three phase	S4L1D-D		
Model 277/480V Three phase	S4L1D-C		
Model 347/600V Three phase	S4L1S-C		
Alternator Type	Four pole, rotating field		
Excitation System	Brushless		
Power factor	0.8		
Number of leads	12 leads, reconnectable		
Stator Pitch	2/3		
Insulation	Class H		
Windings – Temperature Rise	Class F (125/40° C)		
Enclosure (IEC-34-S)	IP23		
Bearing	Single, sealed		
Coupling	Flexible disc		
Amortisseur windings	Full		
Voltage regulation – no load to full load with MX341 AVR	± 1%		
TIF	<50		
Radio Frequency Emissions compliance	Meets requirements of most industrial and commercial applications		
Line harmonics	5% maximum		

## STANDARD FEATURES

Enclosure (If selected)	Engine System	Fuel System
Rust-Proof Fastener with Nylon Washers Protect Finish	Oil Drain Extension	Primary Fuel Filter
High Performance Sound-Absorbing Material (L1)	Air Cleaner	Flexible fuel lines
Gasketed Doors	Fan Guard	<b>Generator set</b>
Air Discharge Hoods for Radiators- Upwards Pointing	Factory Filled Oil	80% Rated Main Line Circuit Breaker
Lift Off Door Hinges	Battery Charging Alternator	Separation of Circuits – Multiple Breakers (load center)
Stainless Steel Lockable Handles	<b>Alternator Systems</b>	Separation of Circuits – High / Low Voltage
Textured Polyester Powder Coat	12 Leads (3-Phase, Non 600V)	Internal Genset Vibration Isolation
<b>Cooling System</b>	Class H Insulation Material	Wrapped Exhaust Piping
Factory-Installed Radiator	Vented Rotor	Standard Factory Testing
Radiator Drain Extension	2/3 Pitch	2 Year/2000 hours Limited Warranty
50/50 Ethylene Glycol Antifreeze	Full Load Capacity Alternator	Silencer Mounted in the Discharged Hood (Enclosed Only)
<b>Electrical Systems</b>	Protective Thermal Switch	Emergency Stop
Battery Cables and Battery Tray	Permanent Magnet Excitation	
Batteries	Skewed Stator	

## CONTROL SYSTEM



- Charge alternator failure alarm
- 4-Line back-lit LCD text display
- Front panel editing with PIN protection
- Customizable status screens
- Power save mode
- 11 configurable inputs
- 8 configurable outputs
- Flexible sensor inputs
- Configurable timers and alarms
- 3 configurable maintenance alarms
- Multiple date and time scheduler
- Configurable event log (250)

- “Protections disabled” feature
- kW protection
- Reverse power (kW) protection
- LED and LCD alarm indication
- Power monitoring (kWh, kVar, kVAh, kVArh)
- Load switching (load shedding and dummy load outputs)
- Independent Earth Fault trip
- Fuel usage monitor and low fuel alarms
- Configurable display languages
- User selectable simultaneous RS232, RS485 & Ethernet communications
- MODBUS RTU & TCP support
- Configurable MODBUS pages
- Fully configurable via DSE Configuration Suite PC software
- Data logging to assist with fault finding
- PLC editor allows user configurable functions to meet specific application requirements
- License-free PC software
- Multiple date and time scheduler
- DSENet<sup>®</sup> expansion compatible

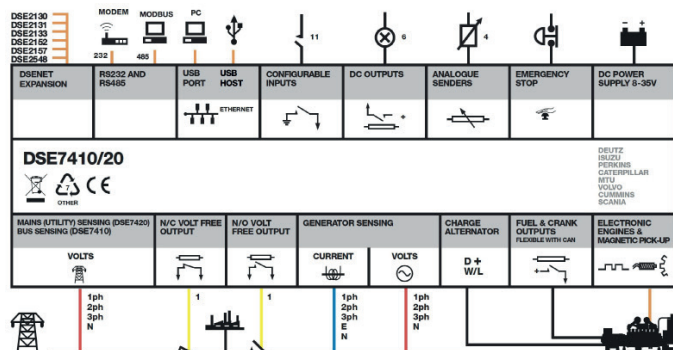

## CONFIGURABLE OPTIONS

ENCLOSURE	ENGINE SYSTEM	ELECTRICAL SYSTEM
Open Skid	Oil heater	Battery Warmer
Weather Enclosure	120V-1ph Water Jacket Heater (with Isolation Valves)	10A Battery Charger
Level 1 Sound attenuated	208V-3ph Water Jacket Heater (with Isolation Valves)	6A Battery Charger
Level 2 Sound attenuated	<b>CIRCUIT BREAKER OPTIONS</b>	10 Positions Load Center (100Amps)
<b>ALTERNATOR SYSTEM</b>	LSI Electronic trip 80% and 100% rated	Remote ESTOP with N3R break glass
Anti-condensation heater	LSIG Electronic trip 80% and 100% rated	120V GFCI receptacle
Alternator upsizing	Second Main Line Circuit Breaker	10A Relay common alarm
Rheostat	Mechanical Lugs	10A Run Relay
MX321 AVR	Shunt trip	8 Led Remote Annunciator on Surface mounted Box
	Auxiliary Contacts for Mail and Secondary Breaker	16 Led Remote Annunciator on Surface mounted Box
		24 Led Remote Annunciator on Surface mounted Box
		<b>GENERATOR SET</b>
		Extended Factory Load Testing
		Extended Warranty
		Seismic Mounts

## ENGINEERED OPTIONS

ENCLOSURE	ENGINE SYSTEM	ELECTRICAL SYSTEM
Snow Hood (only with L2)	Fluid Containment Pan	AC/DC Enclosure Lighting Kit with Timer
Air Outlet Gravity dampers		Enclosure Heater
Air Inlet motorized dampers (only with L2)		240V Twist lock receptacle
<b>CIRCUIT BREAKER OPTIONS</b>	<b>CONTROL SYSTEM</b>	<b>GENERATOR SET</b>
3rd Breaker system	Spare inputs (x4) / output (x4)	Special Testing
Shunt Trip on 3rd Breaker	DSE8610 - Parallel controller with motorized CB	<b>ALTERNATOR SYSTEM</b>
Auxiliary contact on 3rd Breaker	DSE2130 - DSENet Input Expansion Module	Tropical coating
<b>FUEL TANK</b>	DSE2157 - DSENet Output Expansion Module	
Custom Size – 72hr and 96hr	DSE855 - DSENet USB to Ethernet ModBus TCP/IP Communication Module	
Custom type to meet State spec.	DSE892 - DSENet USB to Ethernet ModBus TCP/IP - SNMP Comm. Module	
Vent Extensions	DSE2520 - Remote Display Module	
Overfill Protection Valve		

## OPERATING DATA

FUEL SYSTEM	
Recommended fuel	# 2 - ULSD - EN590
Fuel supply line, min. ID mm (in.)	9.5 - (3/8")
Fuel return line, min. ID, mm (in.)	9.5 - (3/8")
Max. lift, fuel pump, type, m (ft)	1 (3)
Fuel filter	Secondary 5 Microns @ 98% Efficiency

FUEL CONSUMPTION		(Standby Power Rating)
100% load	US Gal/hr (L/hr)	18.5 (70)
75% load	US Gal/hr (L/hr)	13.8 (52.2)
50% load	US Gal/hr (L/hr)	9.3 (35.2)
25% load	US Gal/hr (L/hr)	4.6 (17.4)

COOLING SYSTEM	
Engine cooling air flow	cfm (m <sup>3</sup> /min) 13,772 (390)
Alternator cooling flow	cfm (m <sup>3</sup> /min) 1,463 (41.4)
Combustion air flow	cfm (m <sup>3</sup> /min) 830 (23.5)
Total cooling air flow (engine+alternator+combustion)	cfm (m <sup>3</sup> /min) 16,065 (455)
Total cooling capacity	US gal (liters) 12.6 (48)
Max. Operating Temperature	°F (°C) 122 (50)

EXHAUST	
Exhaust gas flow	cfm (m <sup>3</sup> /min) 863 (22.7)
Max. Exhaust temp at full load degrees	°F (°C) 1040 (560)
Max. permissible back pressure	in H <sub>2</sub> O (kPA) 40 (10)

## Starting Capabilities (sKVA)

	120/240V (1PH)					277/480V					208/240V					347/600V				
	10%	15%	20%	25%	30%	10%	15%	20%	25%	30%	10%	15%	20%	25%	30%	10%	15%	20%	25%	30%
Standard	n/a	n/a	n/a	n/a	n/a	195	330	450	580	750	195	300	430	550	750	180	280	400	540	700
Upsized	n/a	n/a	n/a	n/a	n/a	250	400	580	780	960	230	350	500	650	850	195	300	430	580	730

## Circuit Breaker

	120/240V (1PH)	277/480V	120/208V	120/240V	347/600V
Make and model	n/a	ABB T5N400TW	ABB T7SB1DB000000XX	ABB T6N800TW	ABB T5N300TW
Amps	n/a	400 A	1000 A	800 A	300 A

**DIMENSIONS, WEIGHTS & SOUND LEVELS**

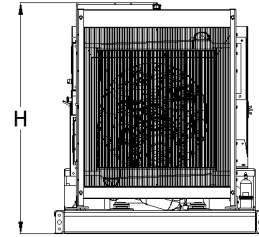
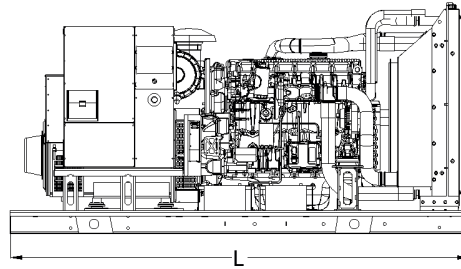
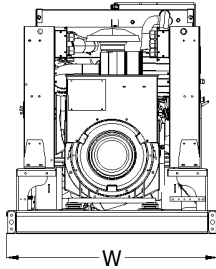

CONFIGURATION	RUN TIME (HOURS)	USABLE CAPACITY (Gal.)	L = Length	W = Width	H = Height	Weight lbs	dBA
OPEN SET	No Tank	-	120"	55"	66"	4,730	
	24	450	184"	55"	13"	2,100	N/A
	48	900	184"	55"	30"	2,800	

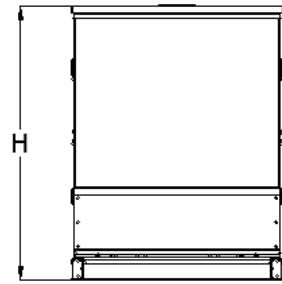
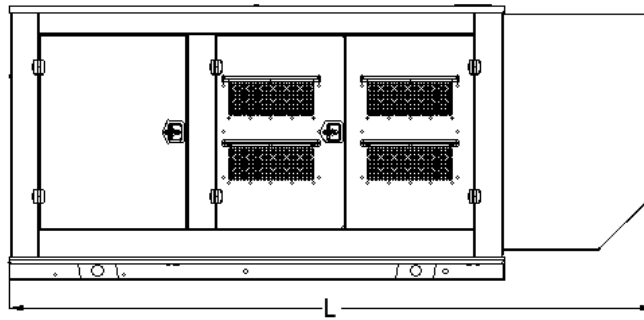
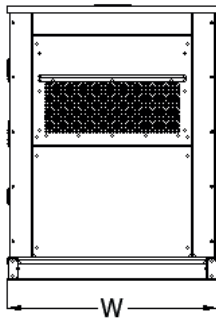

CONFIGURATION	RUN TIME (HOURS)	USABLE CAPACITY (Gal.)	L = Length	W = Width	H = Height	Weight lbs	dBA
WEATHER ENCLOSURE	No Tank	-	160"	55"	68.1"	6,510	
	24	450	184"	55"	13"	2,100	77
	48	900	184"	55"	30"	2,800	
LEVEL 1 ENCLOSURE	No Tank	-	160"	55"	68.1"	6,540	
	24	450	184"	55"	13"	2,100	74
	48	900	184"	55"	30"	2,800	

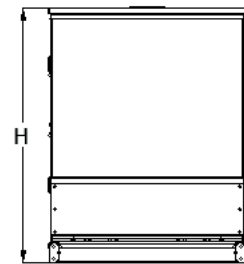
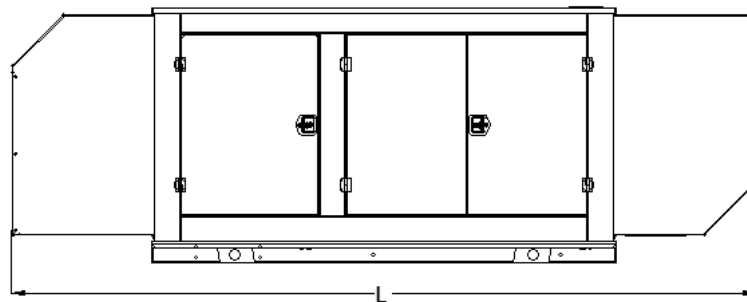
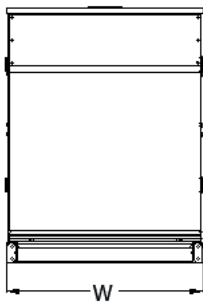

CONFIGURATION	RUN TIME (HOURS)	USABLE CAPACITY (Gal.)	L = Length	W = Width	H = Height	Weight lbs	dBA
LEVEL 2 ENCLOSURE	No Tank	-	200"	55"	68.1"	6,640	
	24	450	224"	55"	13"	2,100	72
	48	900	224"	55"	30"	2,800	

\* All measurements are approximate and for estimation purposes only. Weights are without fuel tank. Sound levels measured at 23ft (7m) and does not account for ambient site conditions.



**Intertek**

Conforms to UL STD 2200  
Certified to CSA STD C22.2#100  
Certified to CSA STD C22.2#14